

1964

THUNDERBIRD



WIRING

DIAGRAM

MANUAL

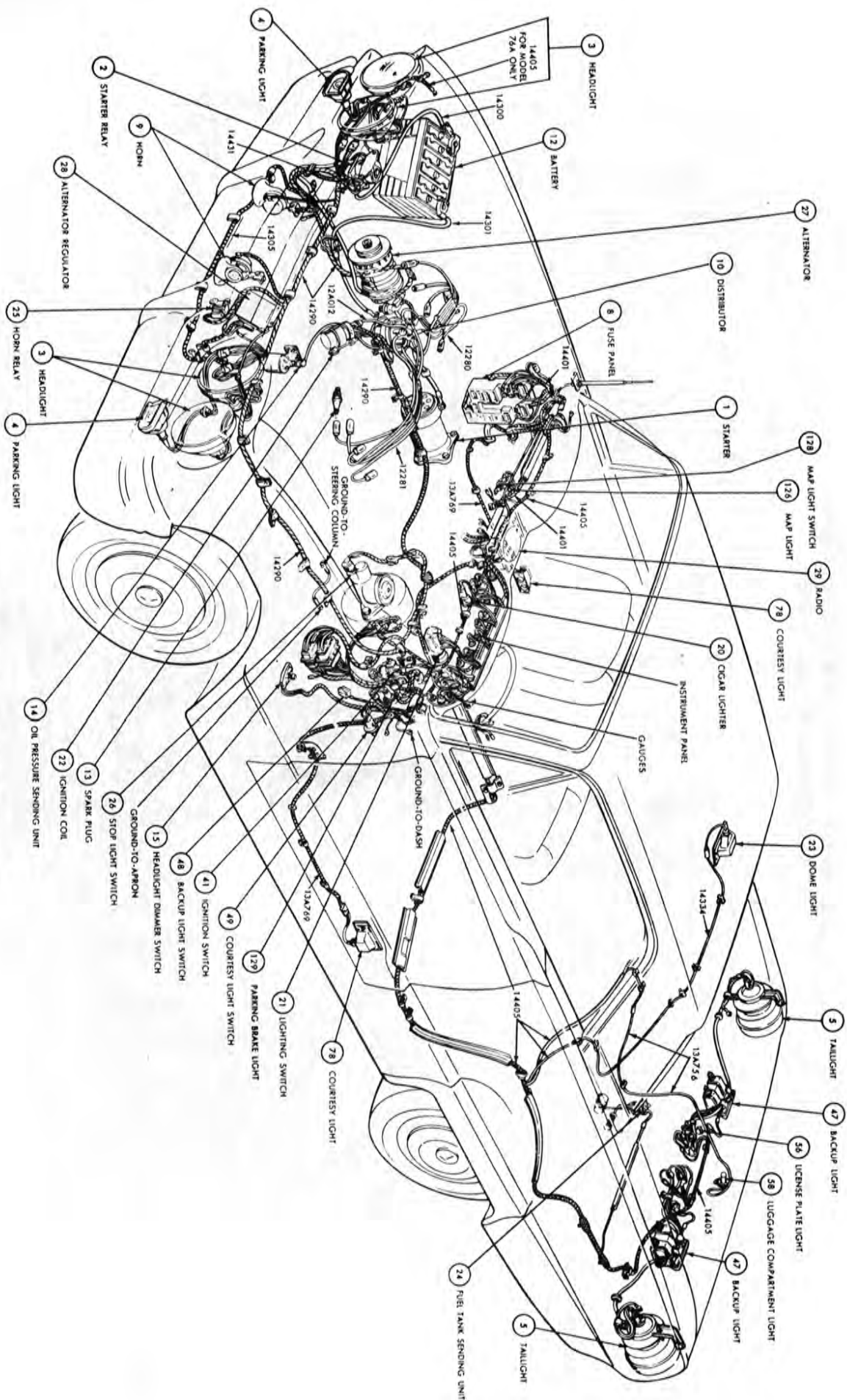

**1964 THUNDERBIRD
MASTER WIRING LOCATOR**

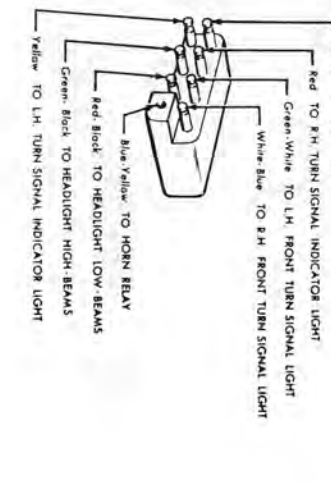
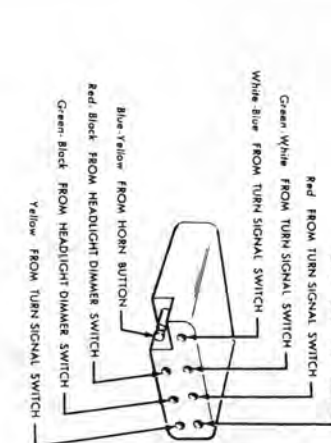
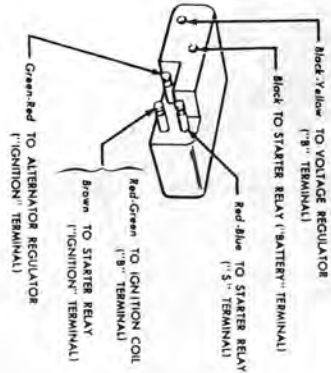
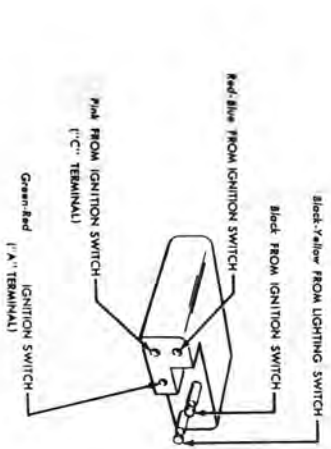
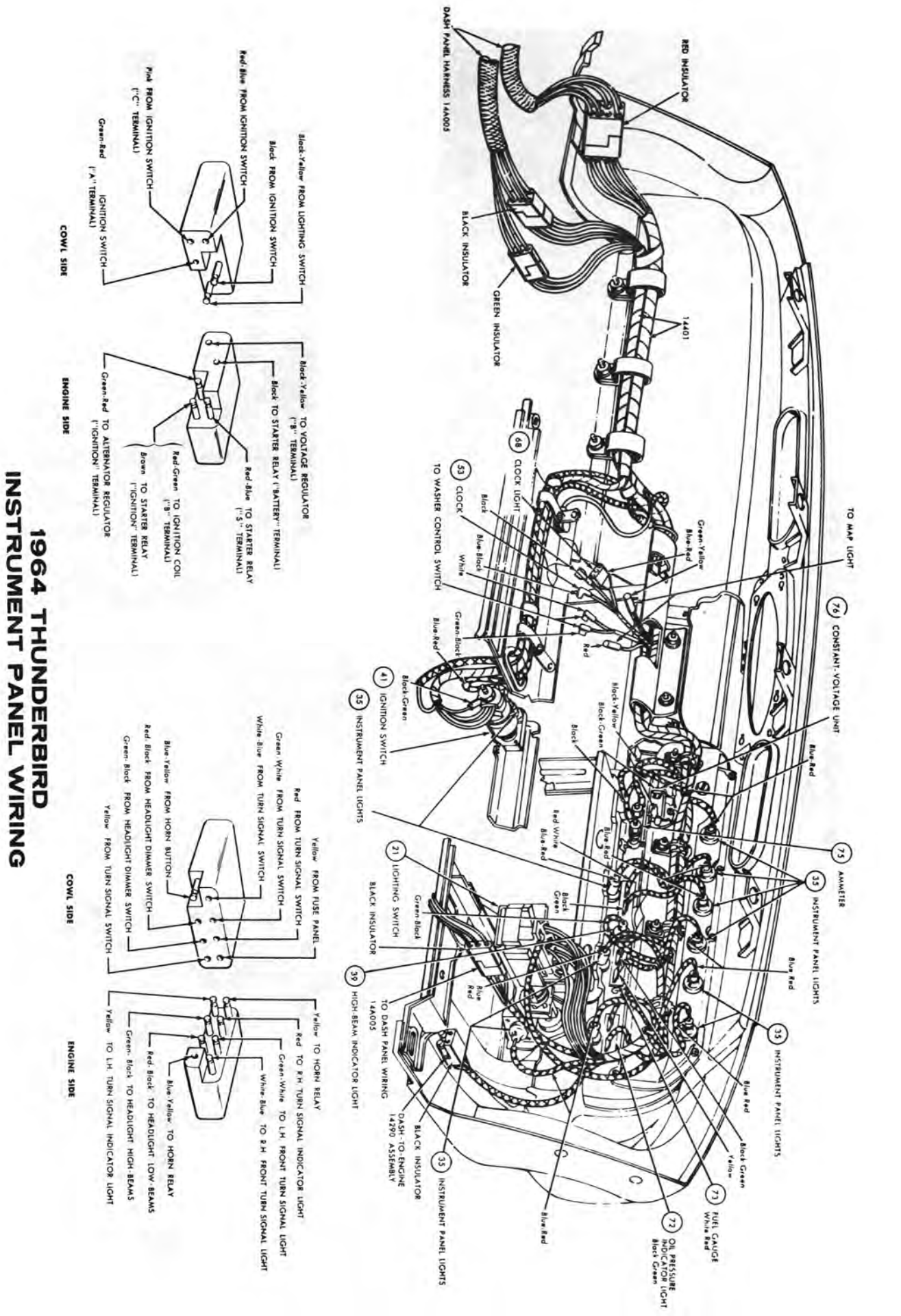

1964 THUNDERBIRD INSTRUMENT PANEL WIRING

1964 THUNDERBIRD IGNITION WIRING

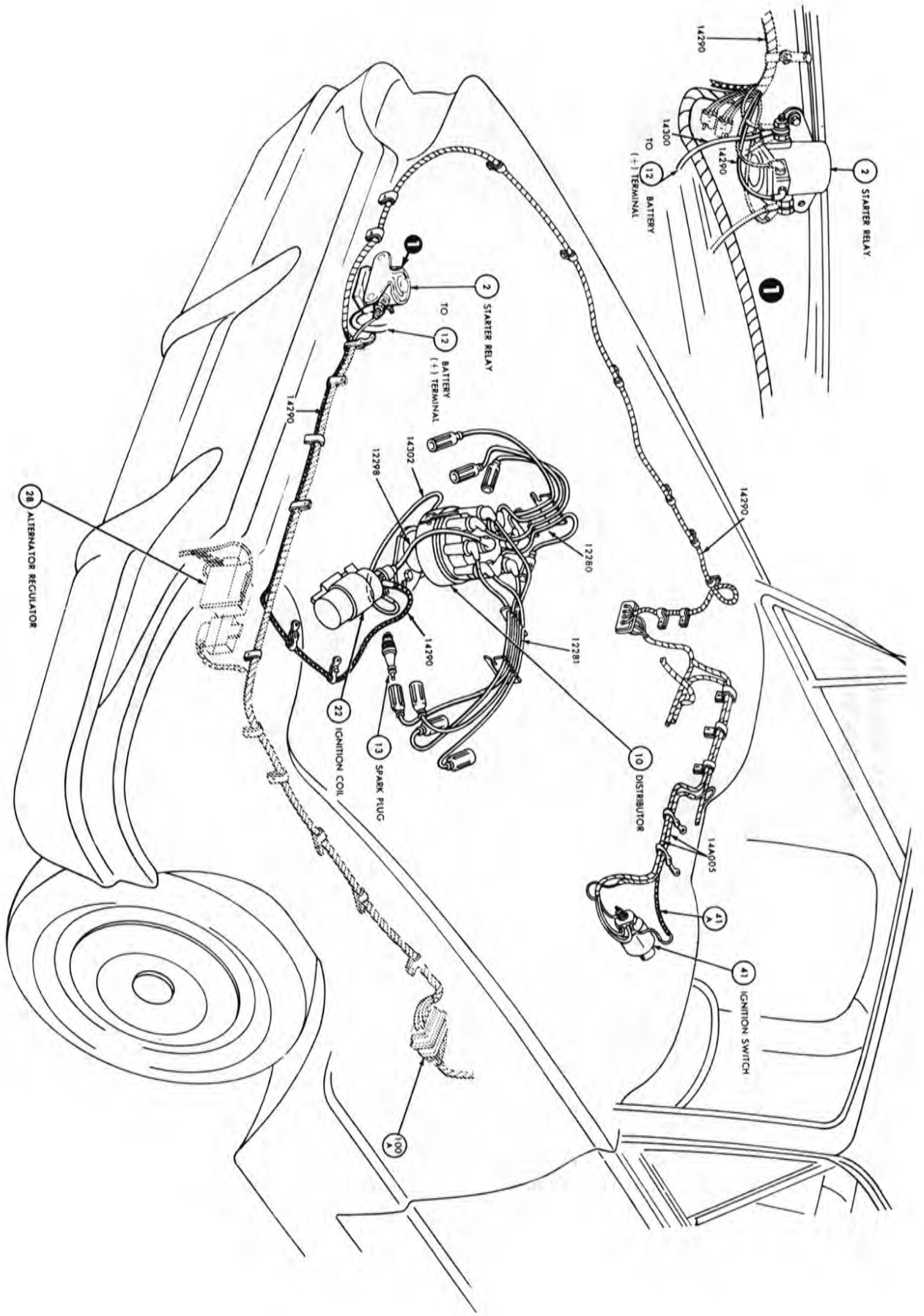

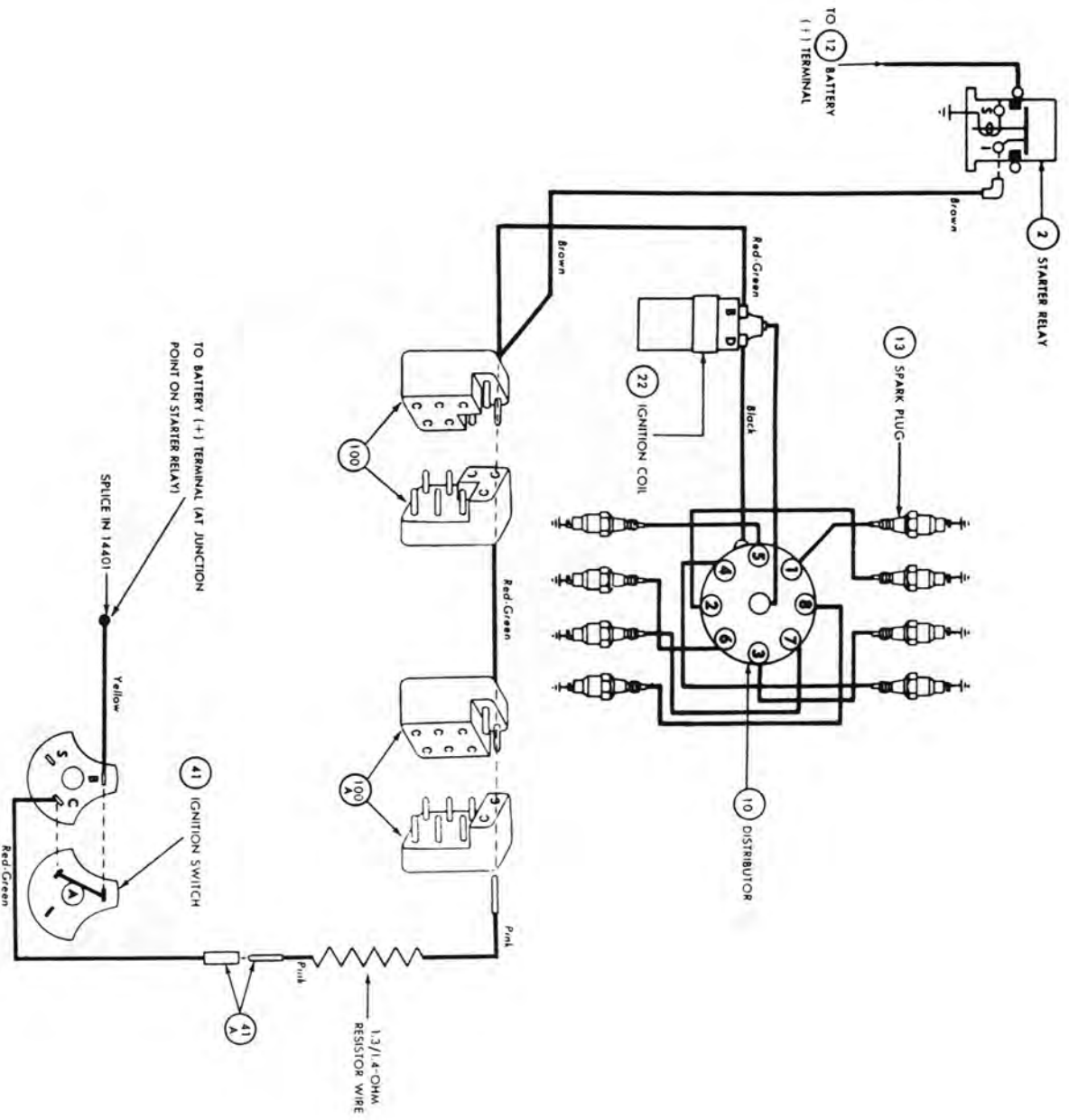

**1964 THUNDERBIRD
IGNITION SCHEMATIC**

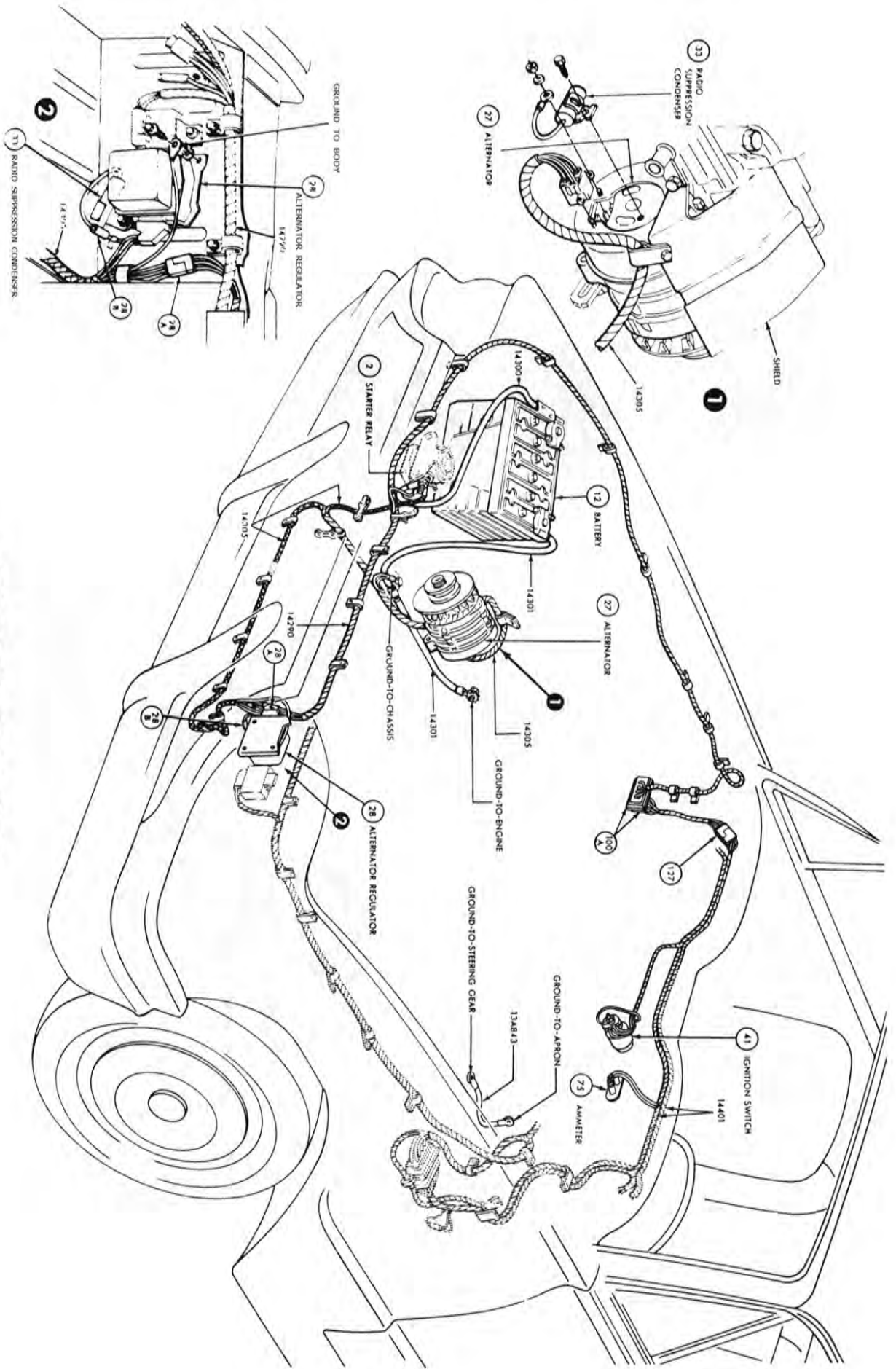

**1964 THUNDERBIRD
ALTERNATOR WIRING**

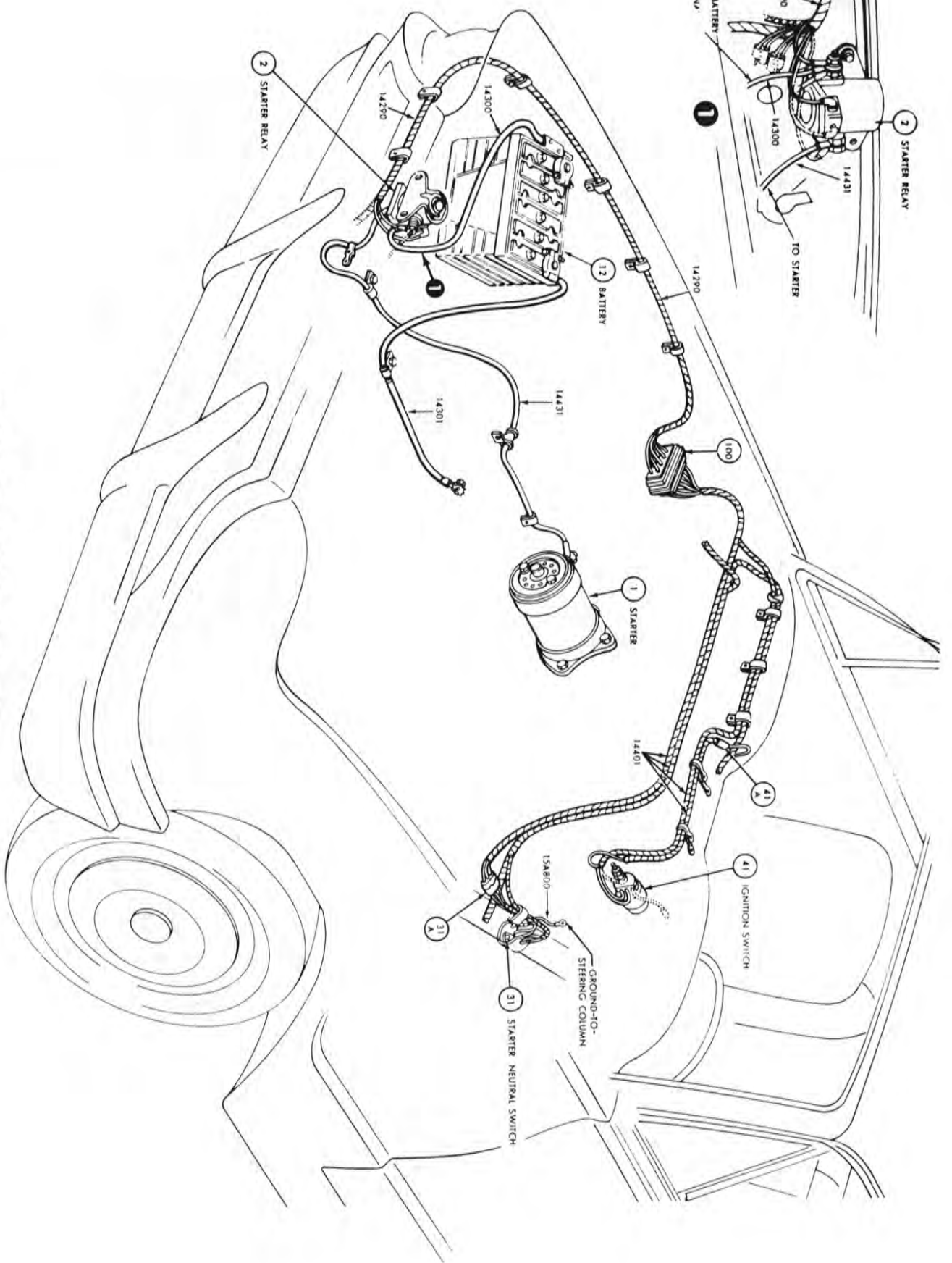
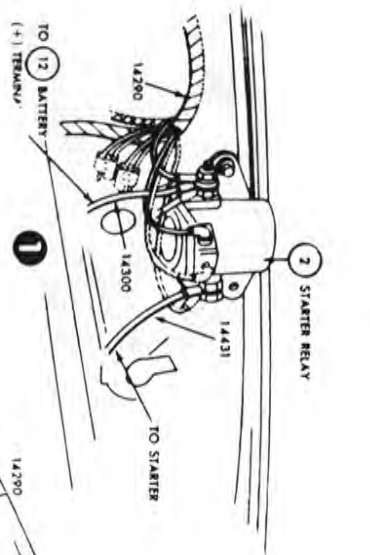

**1964 THUNDERBIRD
STARTER WIRING**

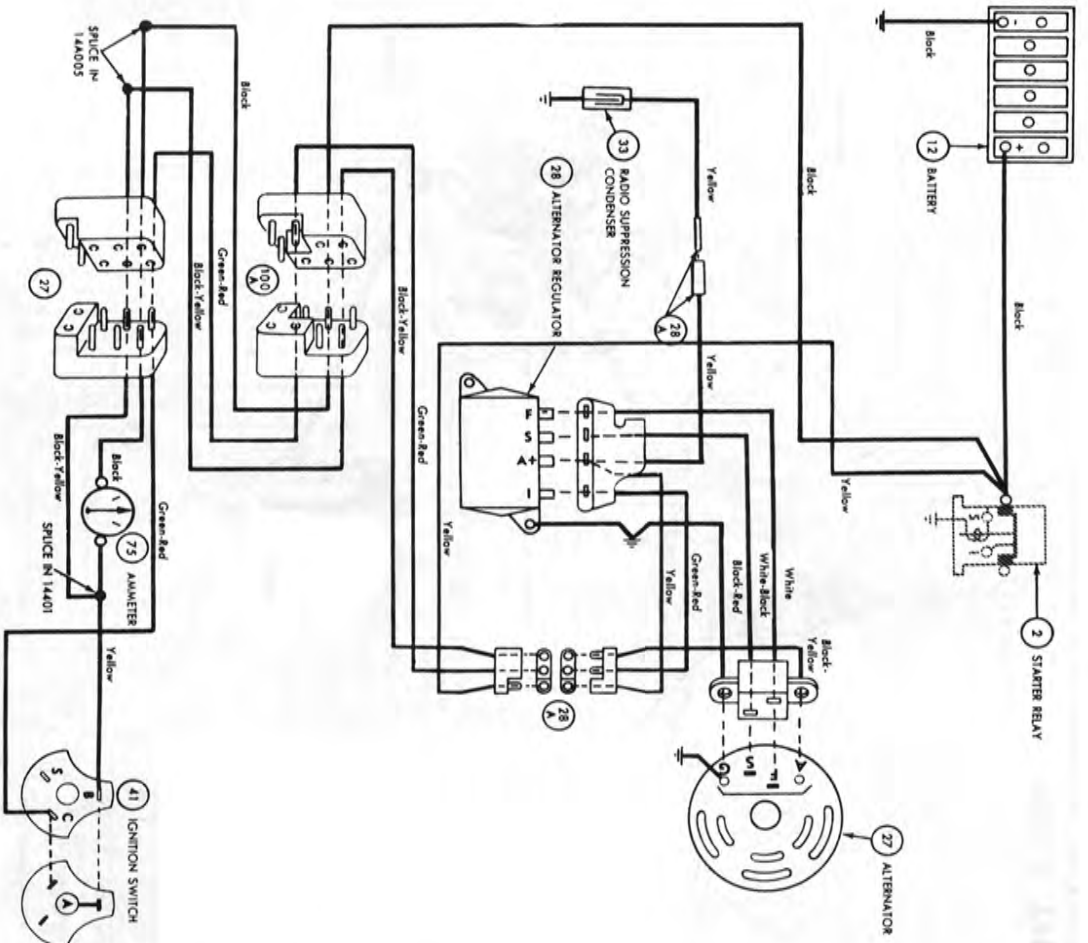

ALTERNATOR SCHEMATIC

1964 THUNDERBIRD

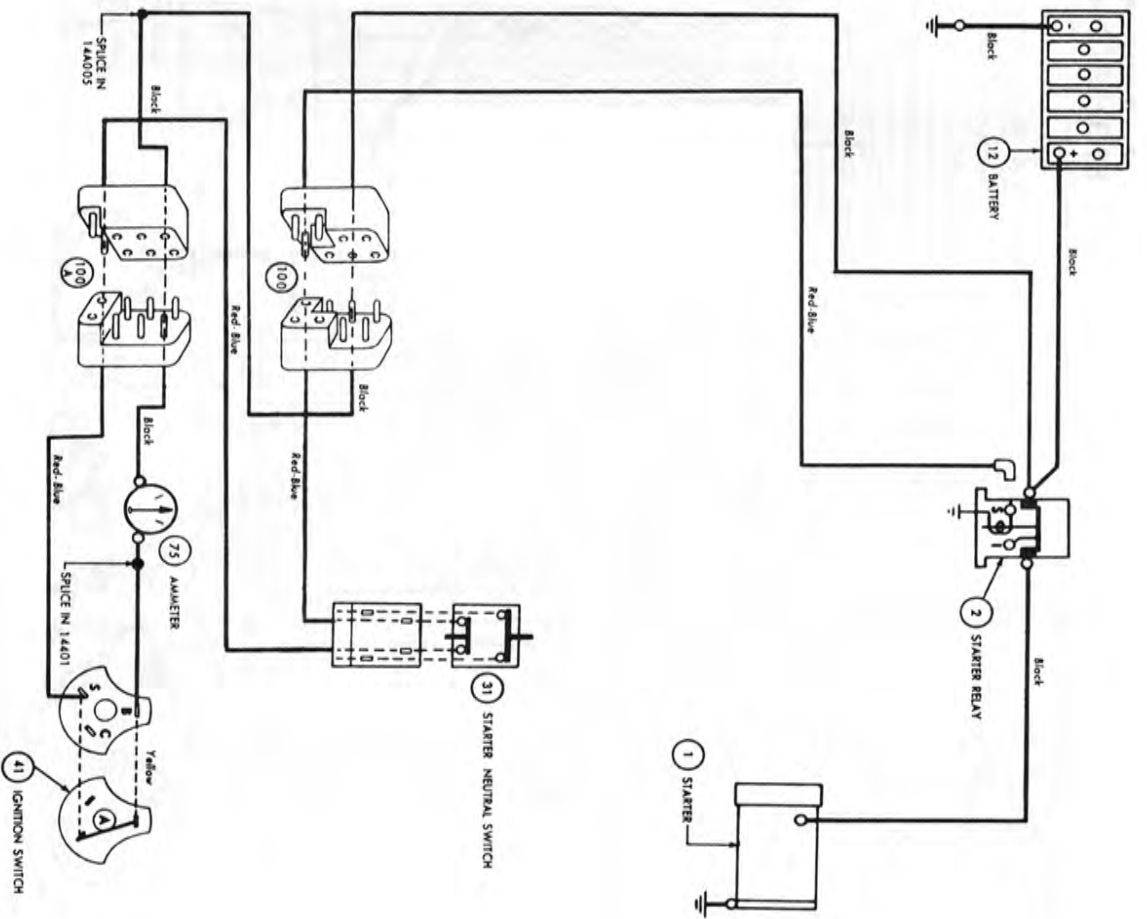

STARTER SCHEMATIC

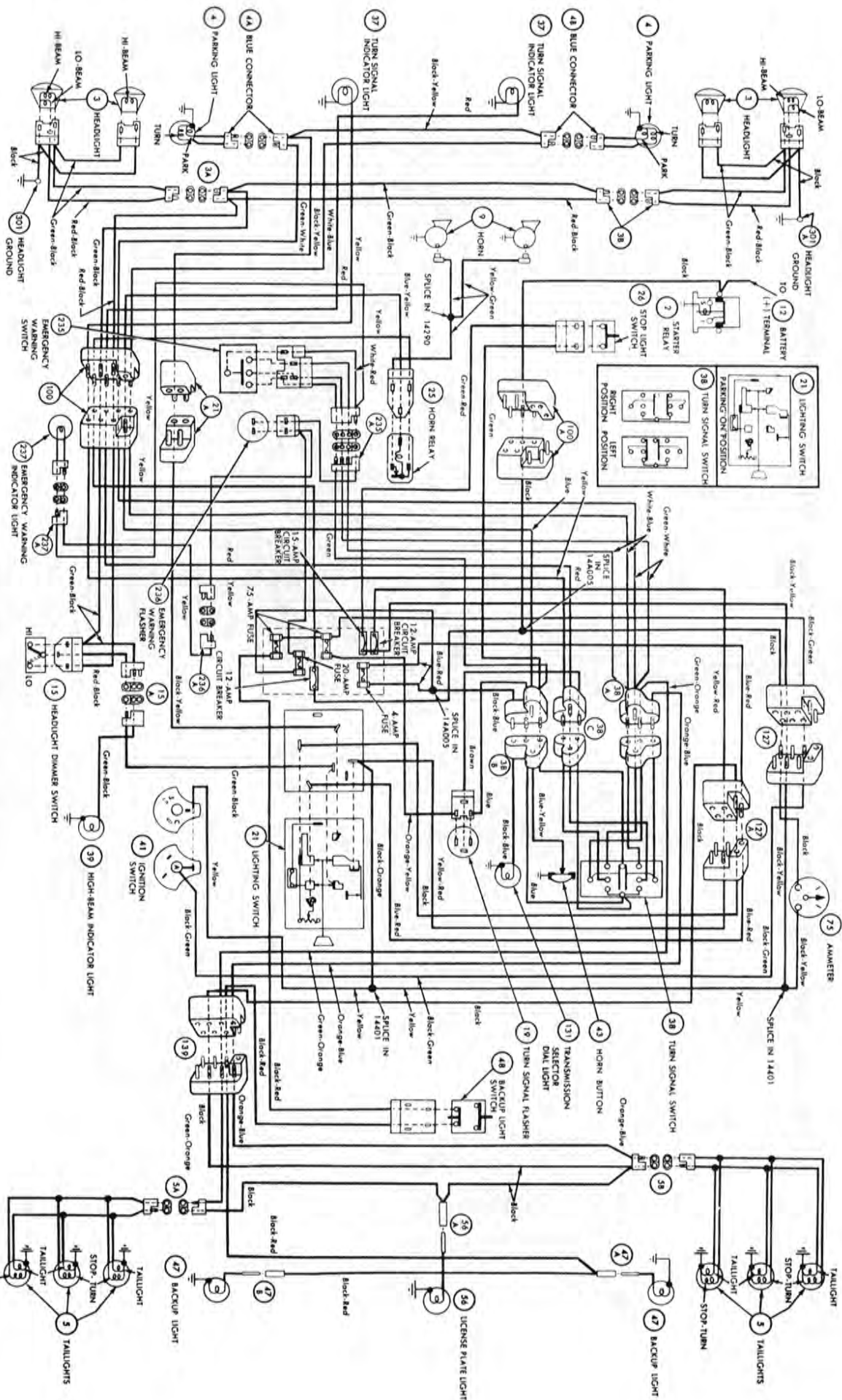

**1964 THUNDERBIRD
EXTERIOR LIGHTING, TURN SIGNALS AND HORN SCHEMATIC**

1964 THUNDERBIRD INTERIOR LIGHTING, WINDSHIELD WIPER AND GAUGE WIRING

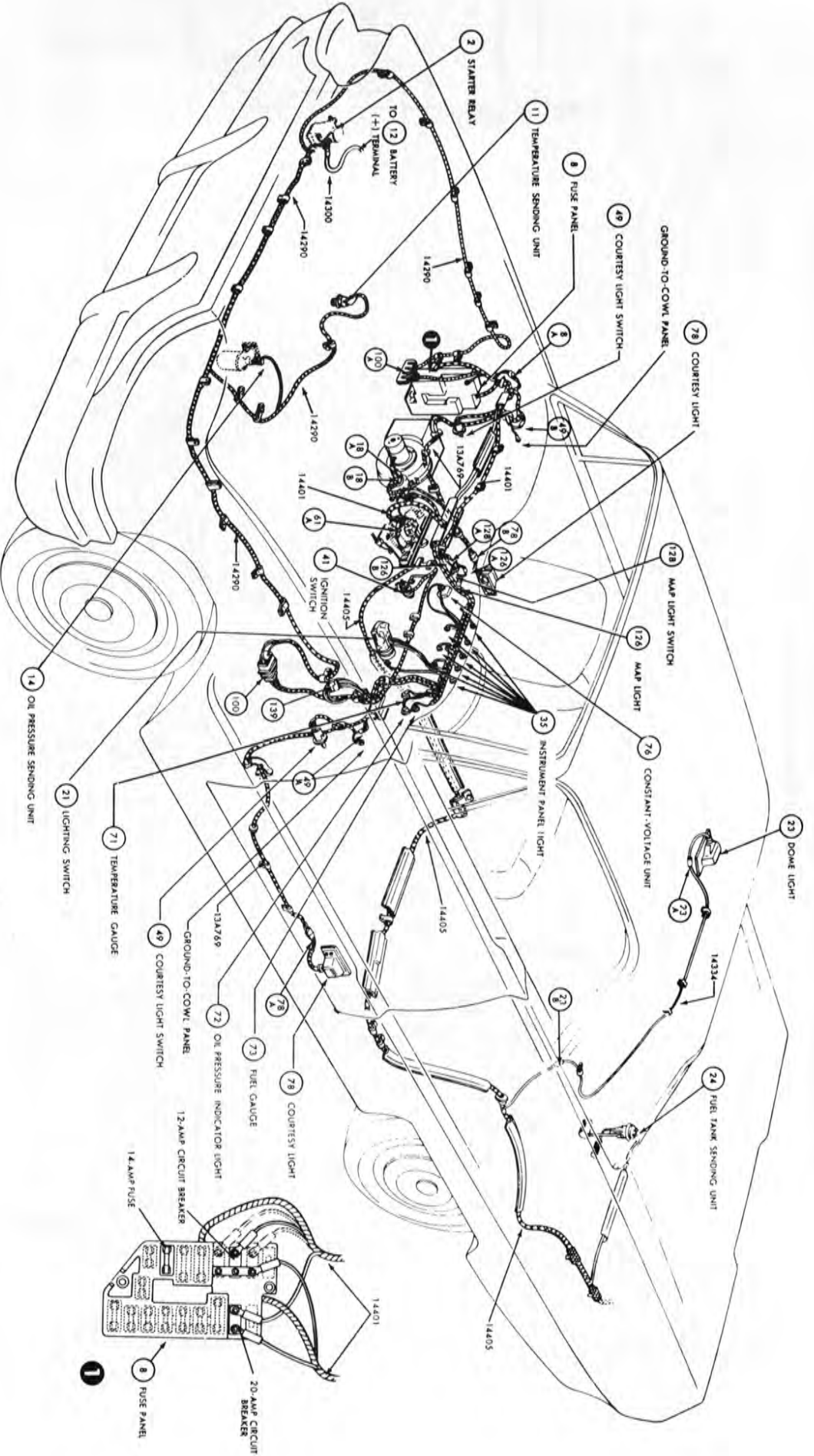

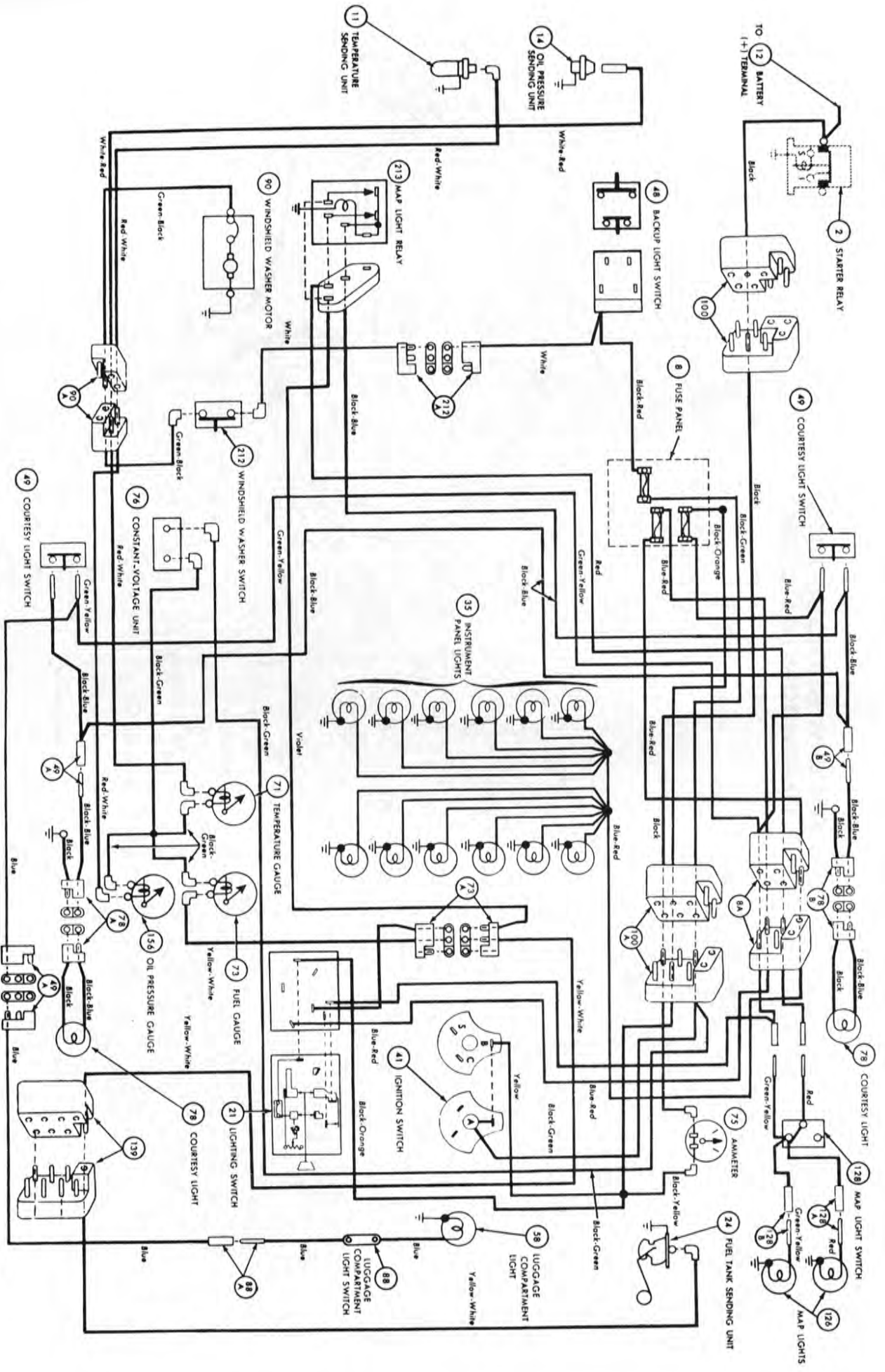

**1964 THUNDERBIRD
 INTERIOR LIGHTING, WINDSHIELD WIPER AND GAUGE SCHEMATIC**

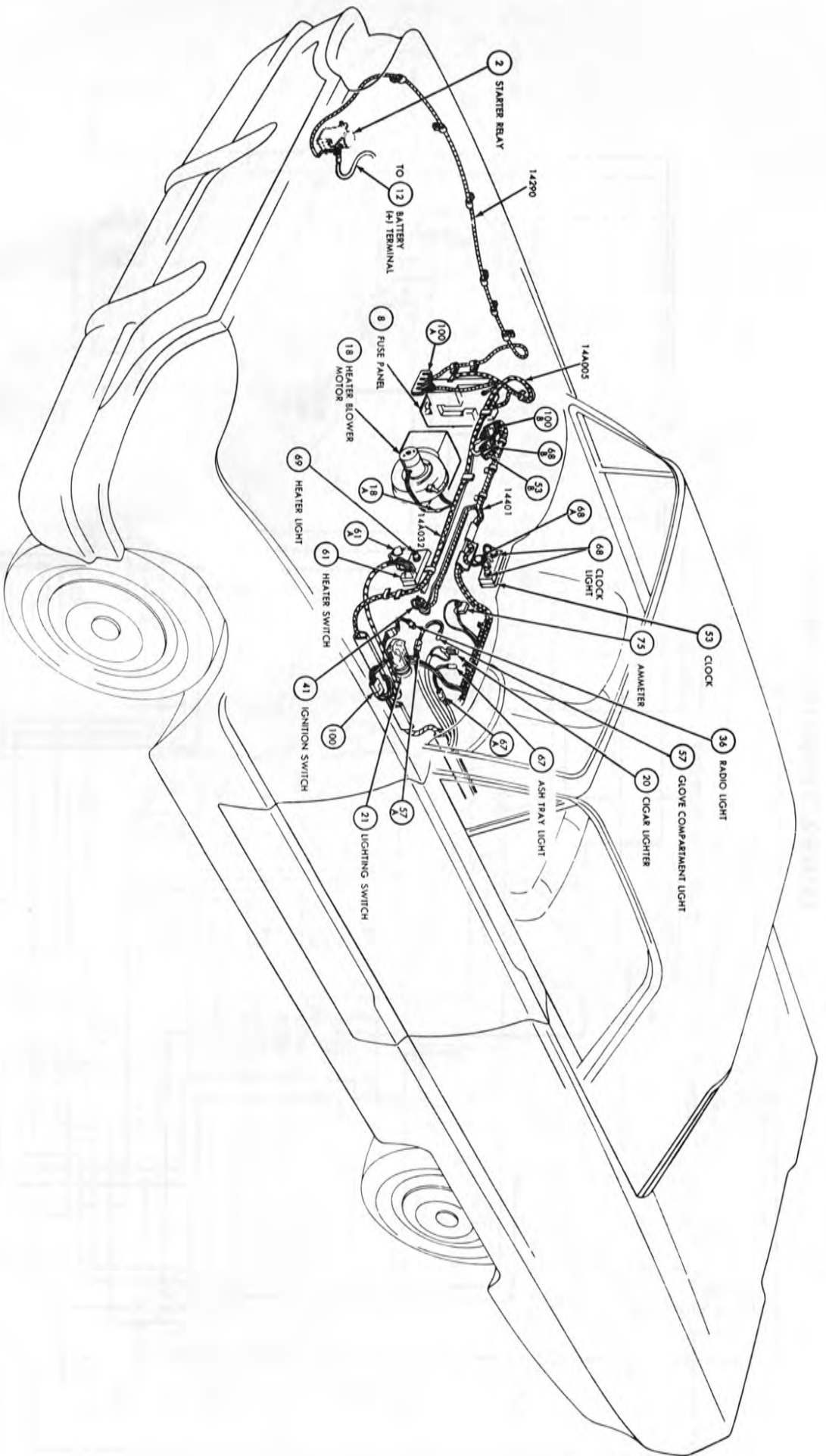

1964 THUNDERBIRD
ACCESSORIES WIRING

1964 THUNDERBIRD ACCESSORIES WIRING

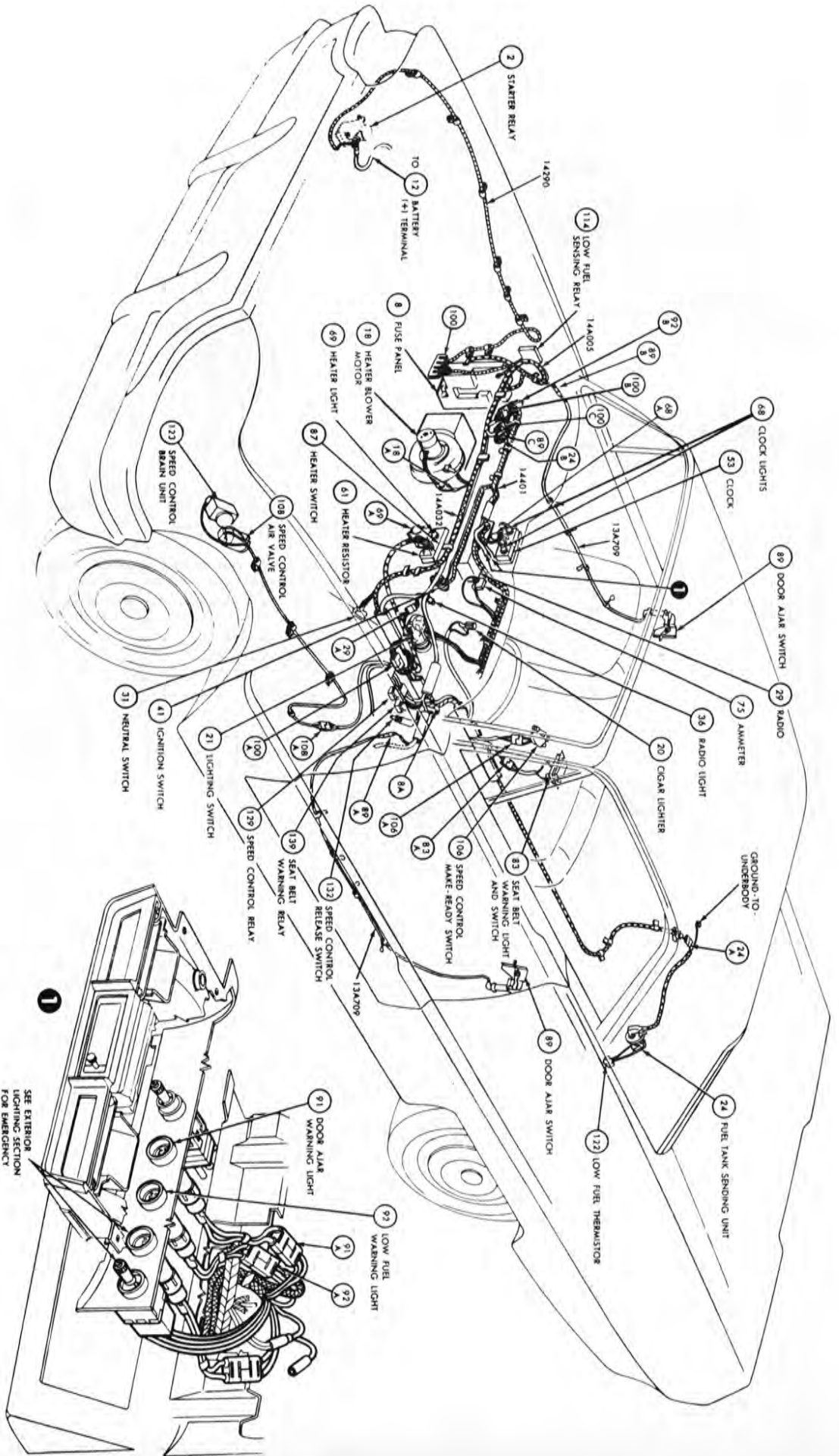

1964 THUNDERBIRD ACCESSORIES SCHEMATIC

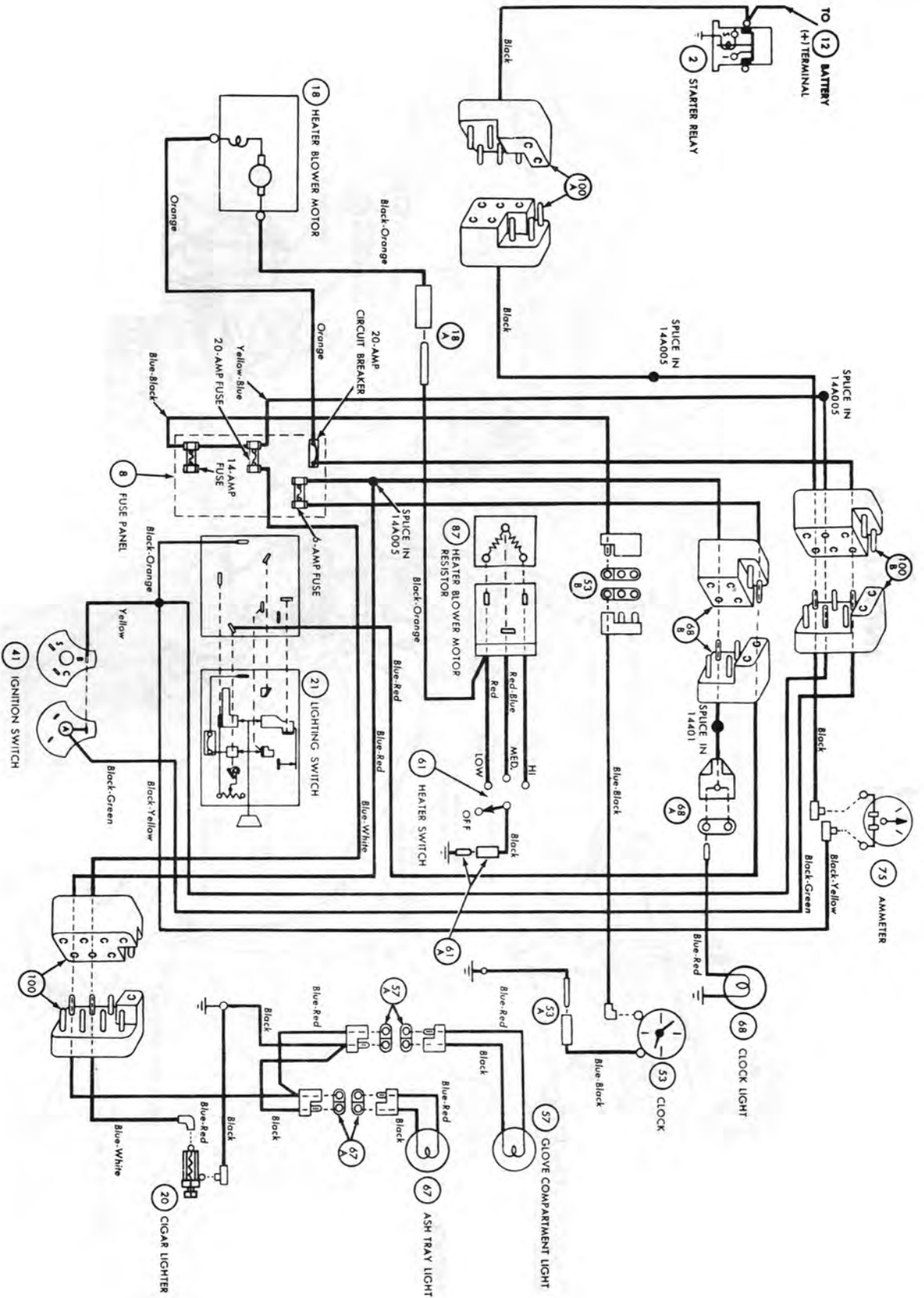

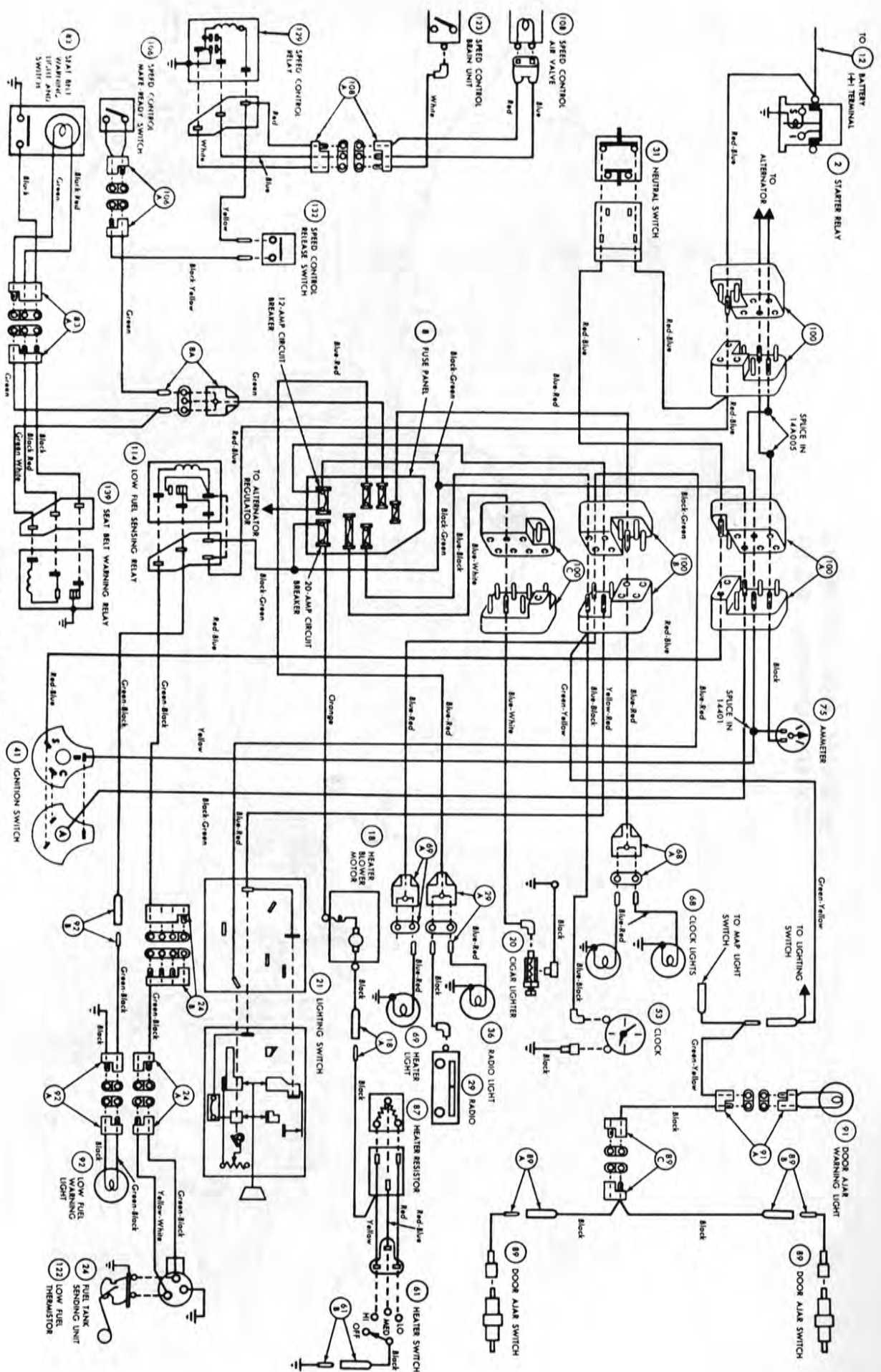

**1964 THUNDERBIRD
ACCESSORIES SCHEMATIC**

1964 THUNDERBIRD POWER TOP WIRING

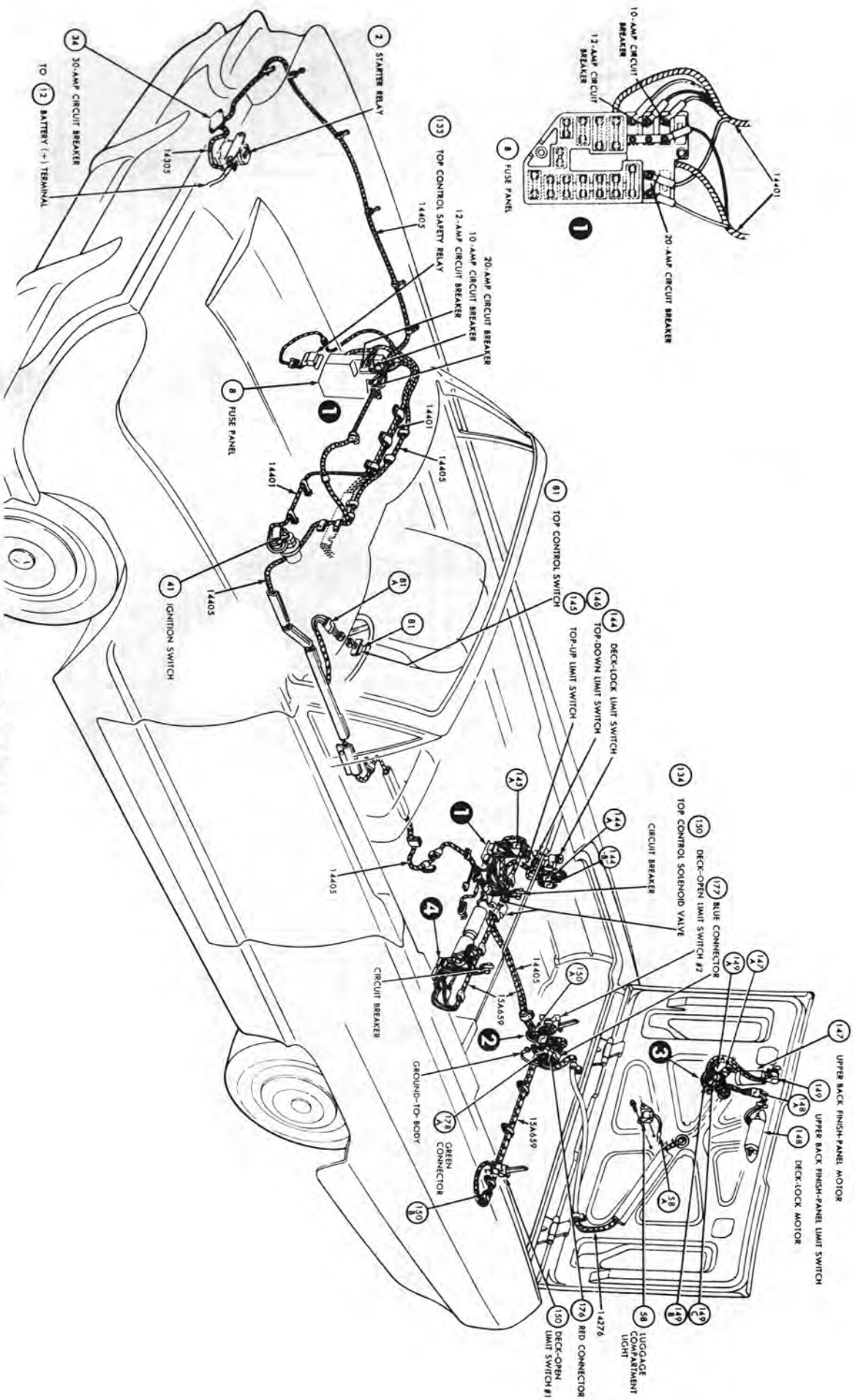

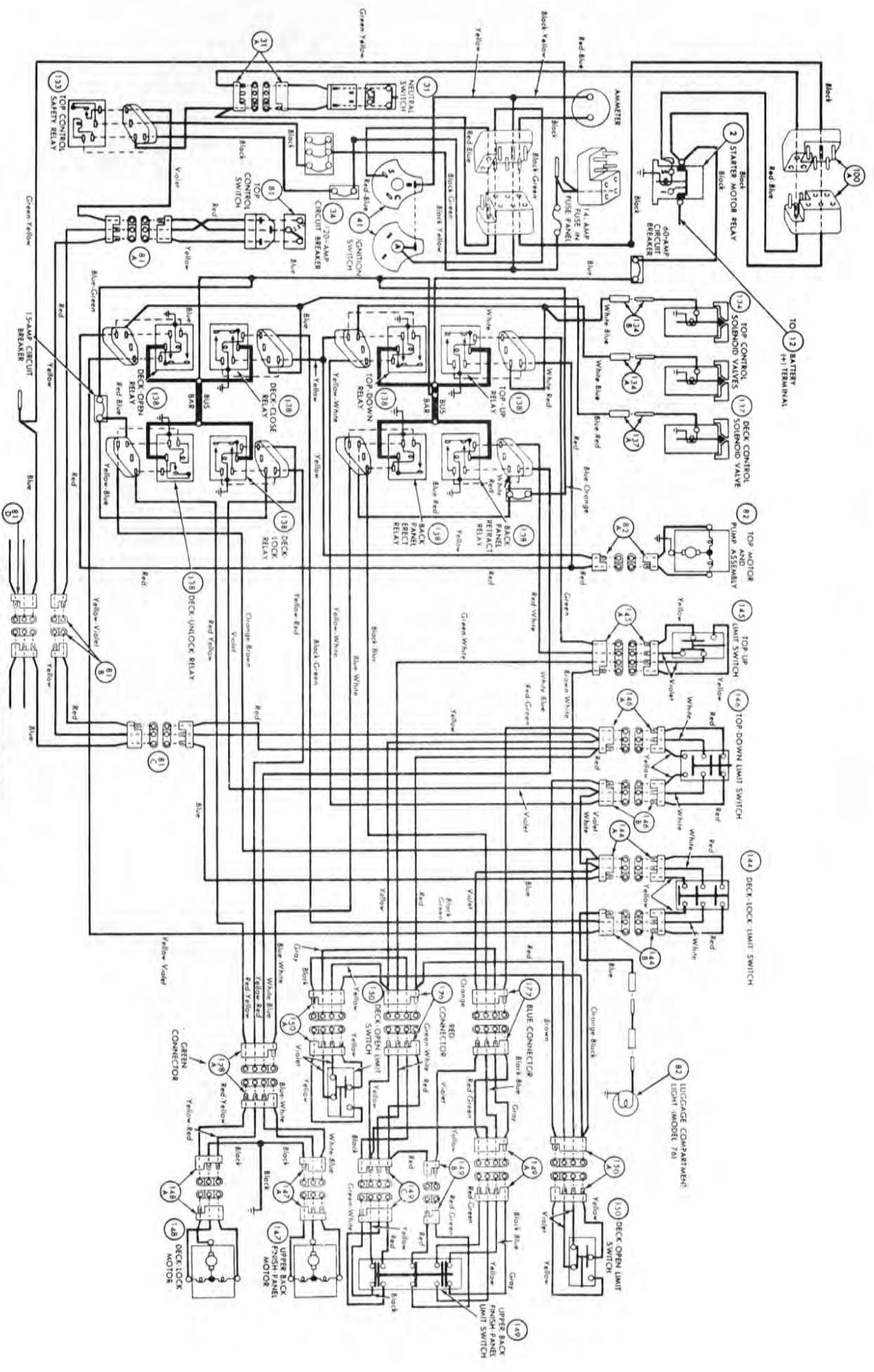

**1964 THUNDERBIRD
POWER TOP SCHEMATIC**

1964 THUNDERBIRD POWER WINDOWS AND SEATS WIRING

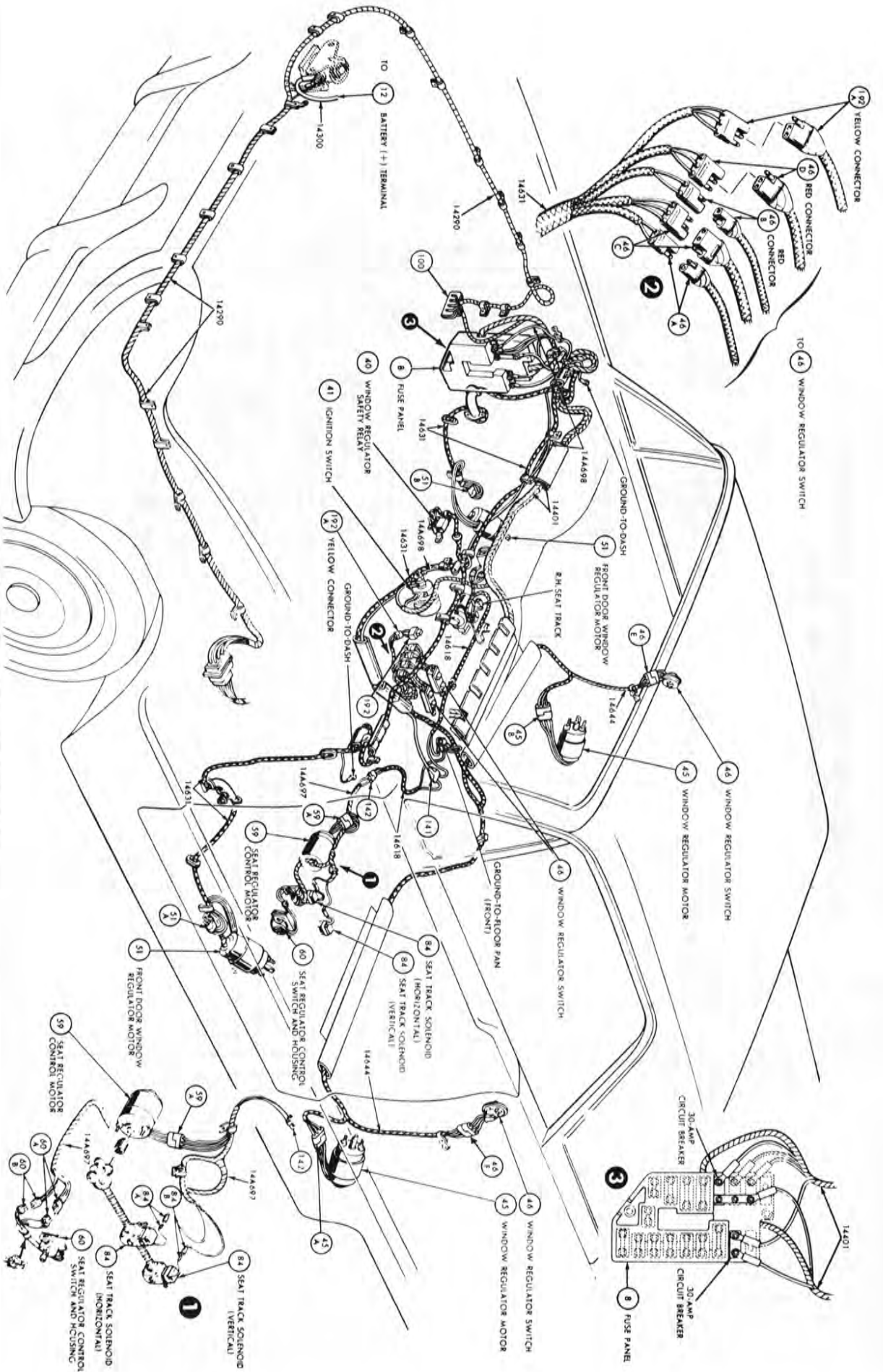

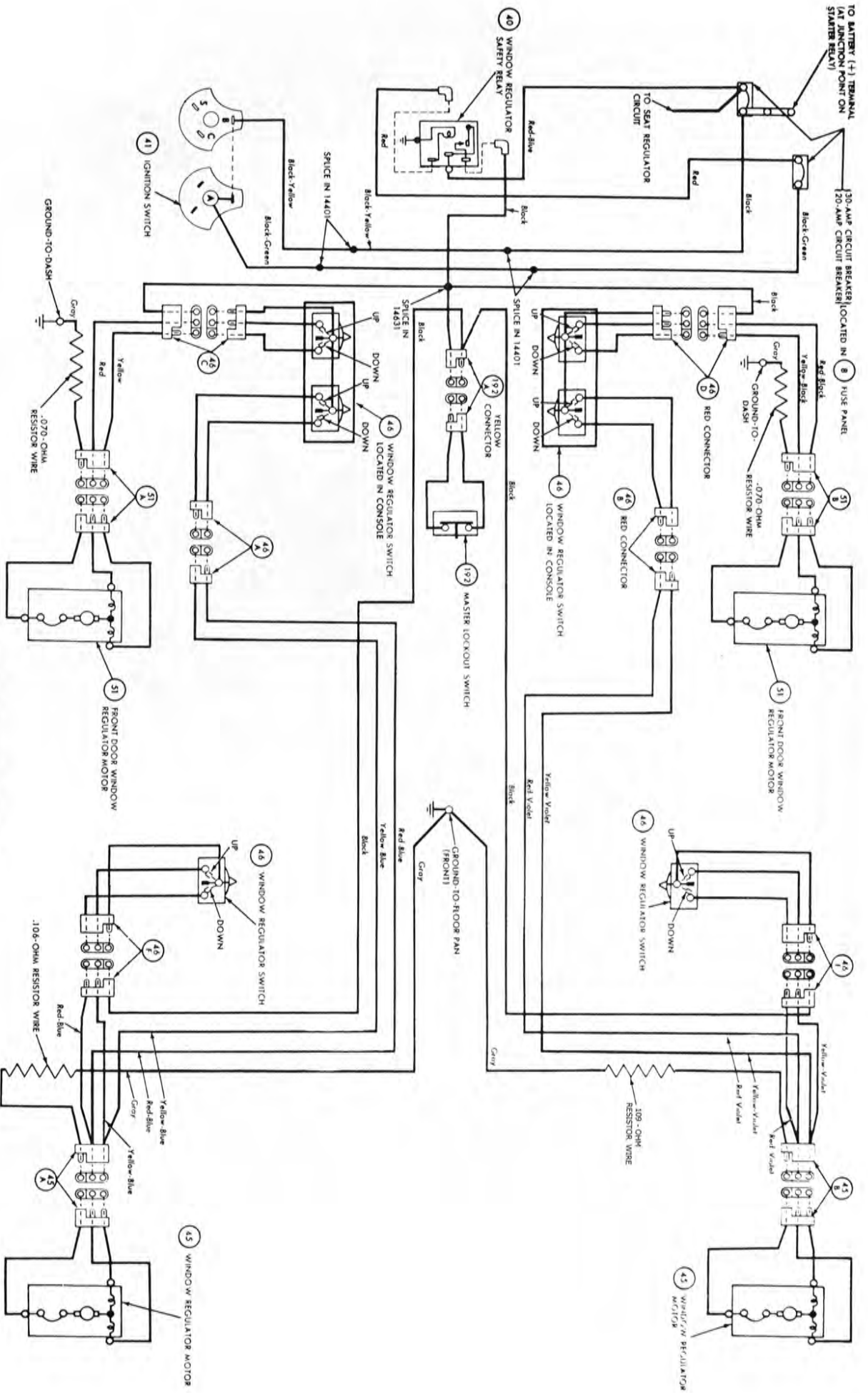

1964 THUNDERBIRD POWER WINDOWS SCHEMATIC

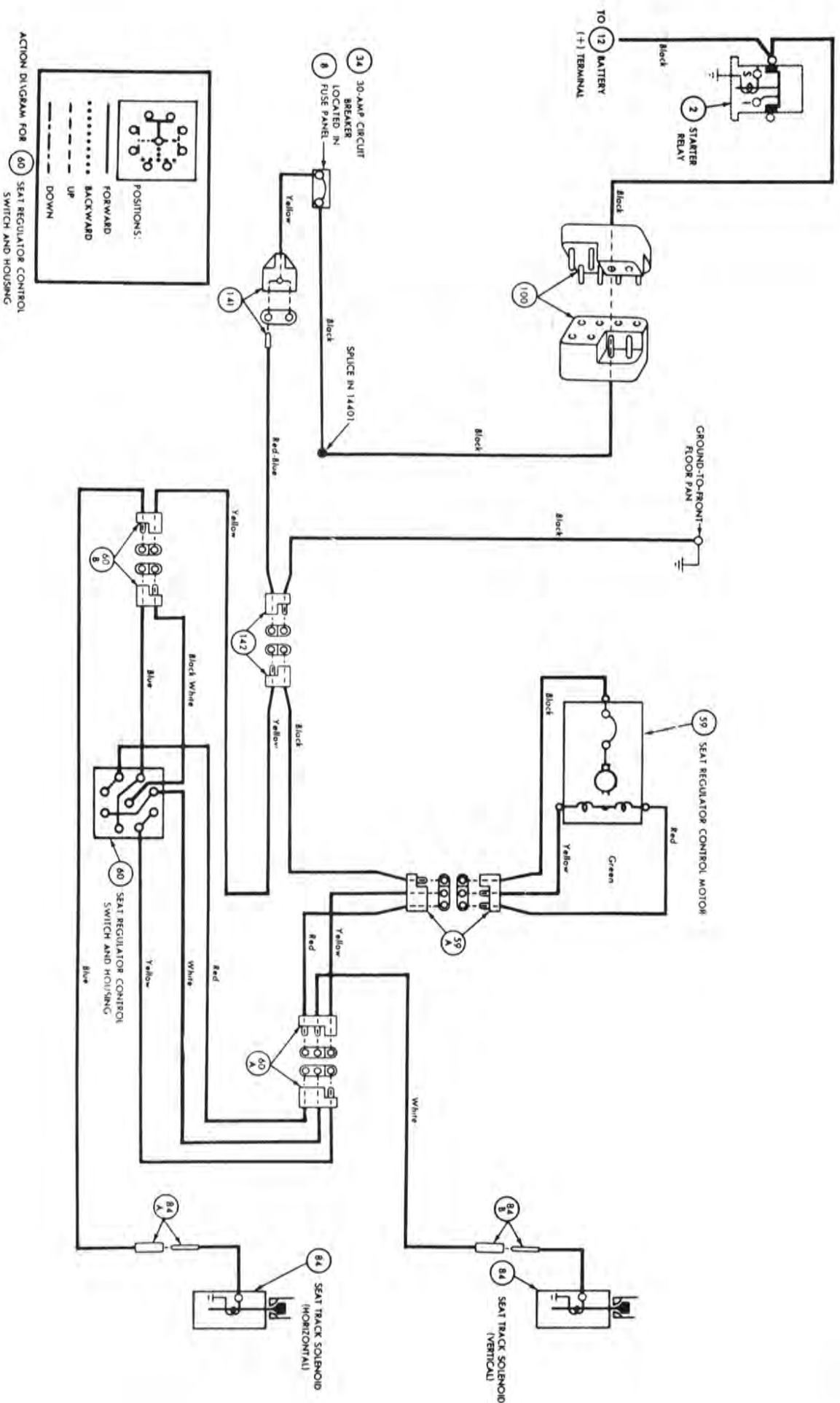

1964 THUNDERBIRD POWER SEATS SCHEMATIC

mp 38

Jim Osborn
R E P R O D U C T I O N S . I N C.
=====

101 Ridgcrest Drive • Lawrenceville, Ga. 30245
(404) 962-7556

Litho in U.S.A.